



SPARTAN

Model 300

Air Switch Conversion Kit

The Air Switch Conversion Kit is intended to update your older Spartan Tool Model 300 to the current electrical design of Spartan Tool sewer cleaning machines. The new design uses a switch actuated by an air bulb to keep electrical connections away from wet floors. The kit includes an outlet box assembly with switches, a new power cord, an air bulb actuator with hose and a motor ground wire. Though this is a relatively simple change, it is important to follow installation instructions provided below for safe operation. This kit will not eliminate shorts or other problems in a faulty electric motor. If your machine is presently has a short or current leak, the motor should be “hi-pot” and leakage current tested at a local electrical repair shop and replaced or repaired, if necessary. In all cases, motor testing is recommended for the safest machine upgrade.



We have also included in this kit a safety decal to be applied to the machine frame for a continual reminder of the importance of correct operation and a detailed instruction booklet to be reviewed by all operators on a regular basis.

Spartan Tool L.L.C.

800.435.3866

www.spartantool.com

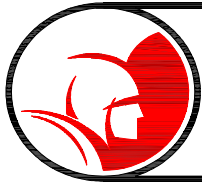

Installation Instructions

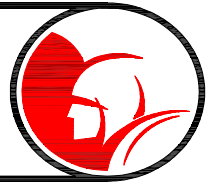

1. Unplug machine from outlet, remove electric foot switch cord. Position Model 300 power unit on convenient, well lit, work bench.
2. Remove electric outlet cover by removing 2 screws on side of cover (Fig. 1). Disconnect all motor cable terminal connections.
3. Inspect motor wires for damage. If insulation is cracked or cut or wire ends frayed, the motor should be replaced or repaired before proceeding. Contact Spartan Tool for instructions.
4. If you motor has 4 rather than 5 wires, it is a "Lamb" motor. For extra ground protection on "Lamb" motors only, attach new blue jumper wire provided to the motor 90° cable connector (Fig.1). Run ground wire along motor cable by inserting through grommet (Fig.1) going into switch housing of machine frame. Pull ground wire slack into switch housing.
5. Your Model 300 has one of several different motors. "Lamb" motor wires are color coded differently than "C", "H" and "S" motors. You must use the correct colors for your machine for proper operations. Note that "Lamb" motors had 4 wires before you add a blue wire. "C", "H" and "S" all have an orange wire and have serial numbers beginning with "C", "H" or "S" respectively. To avoid confusion, determine now which motor you have and cross out the incorrect column in the table below and the incorrect diagram of Fig.2. Use both the table and Fig. 2 to wire your machine in order to double check your work. Remove and save insulation paper shipped around outlet cover assembly. Hold the box cover so that, when mounted, it will fit as shown in Fig. 1 without twisting the wires. Wire as follows:



Wire From	Wire Color		Wire To
	"Lamb"	"C" "H" or "S"	
Motor Ground	Blue (from Step 4)	Green or Blue	Green ground terminal of "male" flush base receptacle.
Motor Field	Black	White or Yellow	Silver terminal on "male" flush base receptacle.
Motor Field	Green	Orange	Center terminal of toggle switch across from air switch connection wire.
Motor Armature	White	Black	Corner terminal of toggle switch on air switch wire side of toggle switch on "R"* side.
Motor Armature	Red	Red	Corner terminal of toggle switch on air switch wire side of toggle switch on "F"* side.

* "F" and "R" are shown on top side of outlet box cover.

NOTE: If armature wires were reversed, motor will run backwards.

Tighten terminals and inspect all wiring for cross contacting terminals.

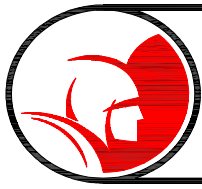

Installation Instructions (cont.)

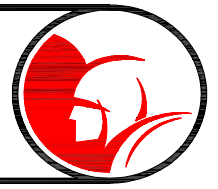

6. Peel back tape on insulation paper of Step 5. Wrap paper around electric components of outlet cover (Fig. 2) and retape. Install box cover and mount with screws provided (Fig. 1).
7.  Make sure cable is completely in drum and cutter removed before proceeding. Test installation in a dry location by plugging electric cord connector body into outlet box receptacle and plug cord into well grounded 115 volt outlet. If you have a circuit tester, check for voltage between the machine frame and a good ground. With toggle switch in the center position, stepping on the air bulb should cause nothing to occur. Depressing bulb with toggle switch in “F” direction, should cause counter clockwise (from front) drum rotation. With toggle switch in “R” direction, depressing air bulb should cause clockwise rotation. If machine does not operate as described or if shocks occur, carefully go over wiring and wiring instructions to detect if an error was made. If not, contact an electric repair service or Spartan Tool for aid.
8. After cleaning machine frame (Fig. 1), peel back safety decal covering and apply to your machine.
9. Insert wiring diagram and attach parts list in your machine parts manual for future reference.



Operation



Your machine now operates in the identical manner as before. If further operating instructions are required, contact Spartan Tool for a new operators manual or for further instructions.

Your machine is now safer in wet conditions. All operators should be aware of the inherent dangers involved in sewer cleaning. We have provided a set of Safety Instructions and ask that all operators review them monthly for their own protection.

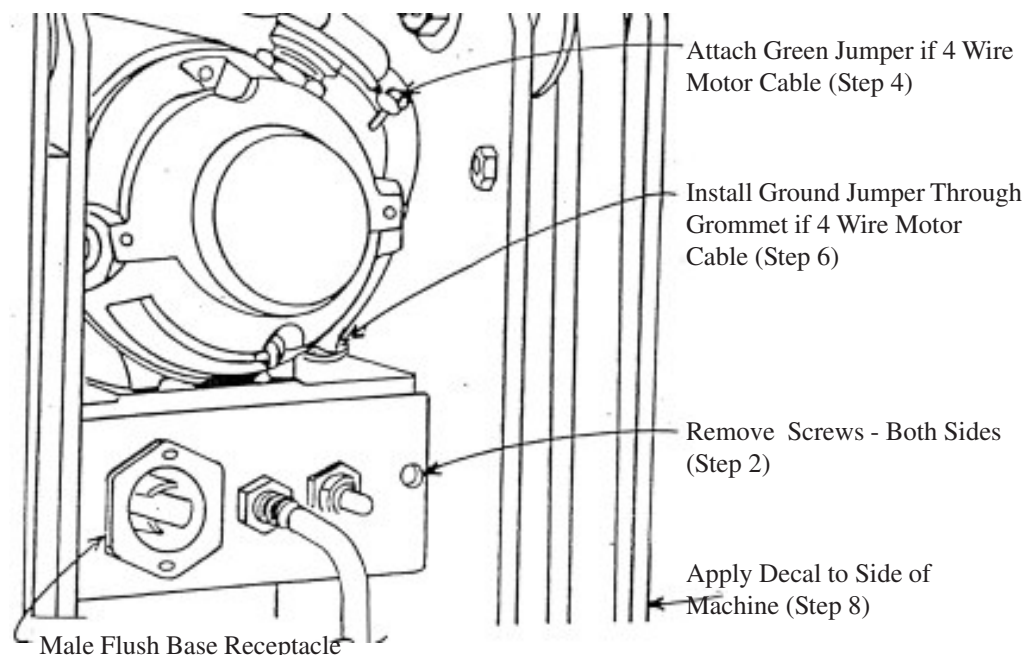
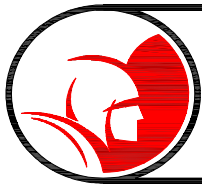

Fig. 1 Machine Back View



Operation (cont.)

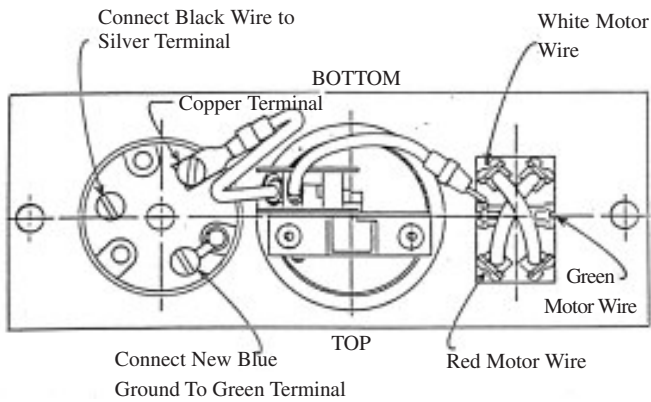
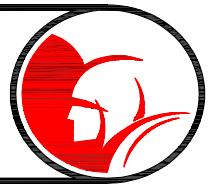

Fig. 2A "Lamb" Motor Wiring
See Step 5 For Identification

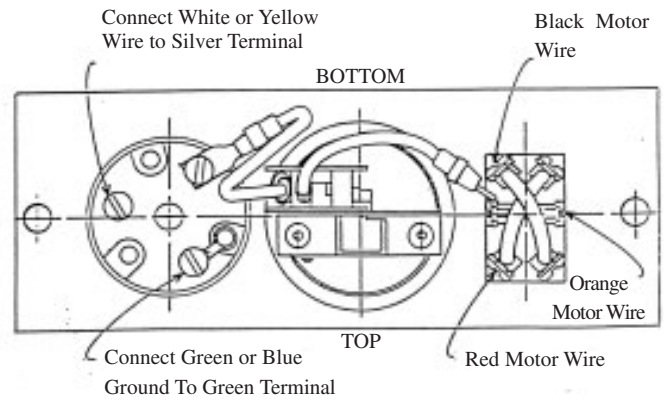
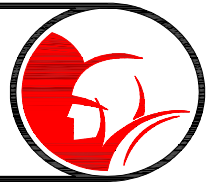

Fig. 2B "C" "H" or "S" Motor Wiring
See Step 5 For Identification



Air Switch Conversion Kit - 44162200



Item	Part #	Description
1	44103800	Assembly Outlet Cover Complete
2	44055500	Air Foot Bulb Assembly (Incl. Hose)
3	04652700	Hose Clamp
4	44037900	Cord Assembly
5	44002600	Air Pressure Switch
6	44038800	Toggle Switch Assembly
7	44101500	Outlet Box Cover With Receptacle Only
	04220200	Decal Warning
	44163000	Spartan Safety Instructions
	02890100	Insulating Paper (Order 2)

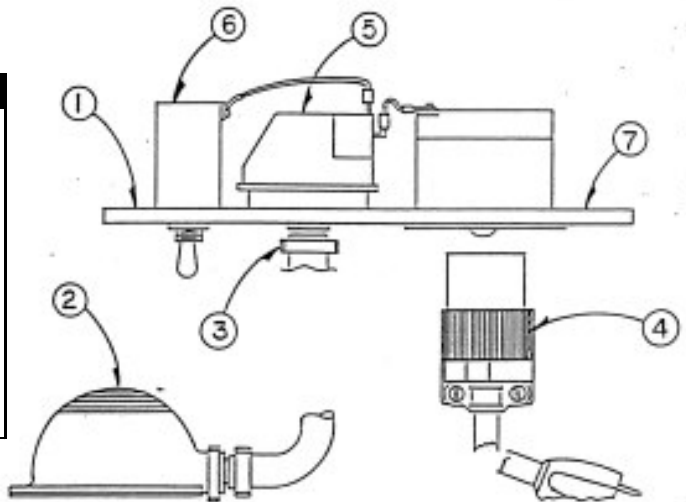

Spartan Tool, L.L.C.

1506 West Division
Mendota, IL 61342
800/435-3866

WWW.SPARTANTOOL.COM